

Dual Beam Tube D 1000654

Instruction sheet

11/17 ALF

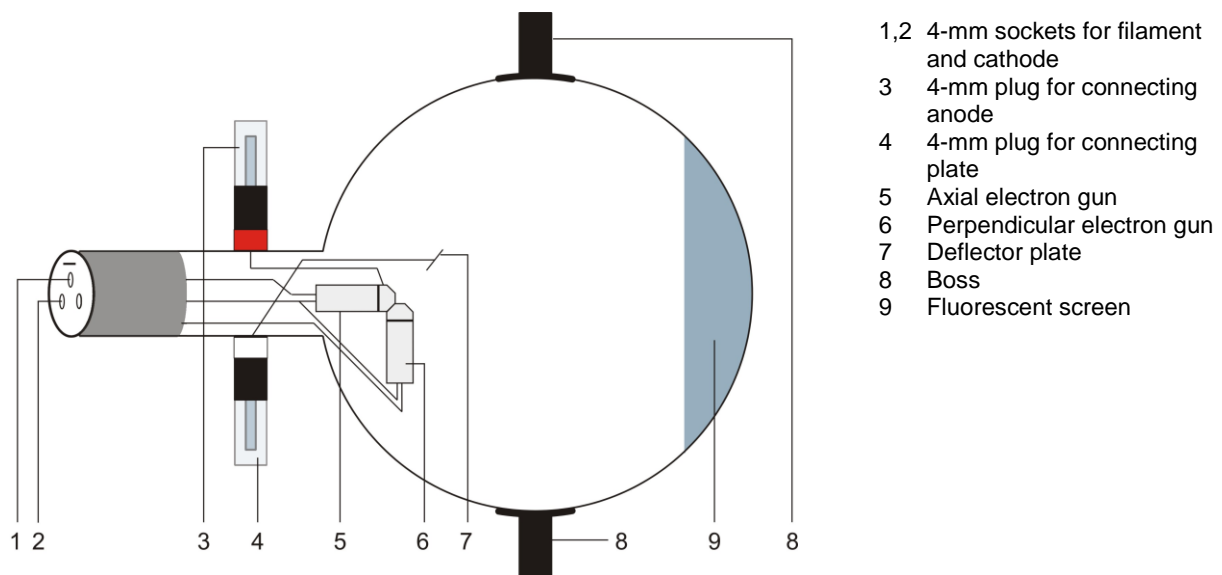

- 1,2 4-mm sockets for filament and cathode
- 3 4-mm plug for connecting anode
- 4 4-mm plug for connecting plate
- 5 Axial electron gun
- 6 Perpendicular electron gun
- 7 Deflector plate
- 8 Boss
- 9 Fluorescent screen

1. Safety instructions

Hot cathode tubes are thin-walled, highly evacuated glass tubes. Treat them carefully as there is a risk of implosion.

- Do not subject the tube to mechanical stresses.
- Do not subject the connection leads to any tension.
- The tube may only be used with tube holder D (1008507).

If voltage or current is too high or the cathode is at the wrong temperature, it can lead to the tube becoming destroyed.

- Do not exceed the stated operating parameters.
- When the tube is in operation, the terminals of the tube may be at high voltages with which it is dangerous to come into contact.
- Only change circuits with power supply switched off.
 - Only exchange tubes with power supply switched off.

When the tube is in operation, the stock of the tube may get hot.

- Allow the tube to cool before dismantling.

The compliance with the EC directive on electromagnetic compatibility is only guaranteed when using the recommended power supplies.

2. Description

The dual beam tube can be used to determine the specific charge e/m from the diameter of the path followed by electrons fired into the tube from a perpendicularly mounted gun with a vertically aligned magnetic field and observation of the spiral path followed by electrons fired axially into a co-axial magnetic field.

The dual beam tube is a partly evacuated electron tube, filled with neon at low pressure and equipped with both axial and perpendicular electron guns. The electron beams are perpendicular to one another and a common deflector plate is provided for both guns. The electron beam source is an oxide cathode heated indirectly via a heating coil. The electron paths show up as a fine, orange beam due to impact excitation of the neon atoms.

3. Technical data

Filament voltage:	max. 7.5 V AC/DC
Anode current:	max. 30 mA
Anode voltage:	Maximum value so that the anode current \leq 30 mA (typical 120-300 V DC)
Deflector voltage:	max. 50 V DC
Glass bulb:	130 mm dia. approx.
Total length:	260 mm approx.
Gas filling:	Neon

4. Operation

To perform experiments using the dual beam tube, the following equipment is also required:

1 Tube holder D	1008507
1 DC power supply 500 V (@230 V)	1003308
or	
1 DC power supply 500 V (@115 V)	1003307
1 Helmholtz pair of coils D	1000644
2 Analogue multimeter AM50	1003073

4.1 Setting up the tube in the tube holder

The tube should not be mounted or removed unless all power supplies are disconnected.

- Push the jaw clamp sliders on the stanchion of the tube holder right back so that the jaws open.
- Push the bosses of the tube into the jaws.
- Push the jaw clamps forward on the stanchions to secure the tube within the jaws.

4.2 Removing the tube from the tube holder

- To remove the tube, push the jaw clamps right back again and take the tube out of the jaws.

4.3 Remarks

1. Limiting of anode current: to avoid an excessive degree of emission of positive ions towards the electron emitting chemicals of the cathode, the anode current should be limited to below 30 mA wherever possible. Higher current may be tolerated for a short time but over long periods it reduces the lifespan of the tube.
2. Thermal stability of the cathode: for the same reason, you should avoid starting the electron gun when the cathode is cold and only just heating up.
3. Focussing the beam: Small voltages U_P applied to the deflector plates enable the beam to be focussed. Voltages greater than 6 V cause results to deteriorate.

5. Example experiments

5.1 Determination of e/m

An electron of charge e moving at velocity v perpendicularly through a magnetic field B experiences a force F that is perpendicular to both B and v and the magnitude of which is given by:

$$F = evB$$

This causes the electron to follow a circular electron path in a plane perpendicular to B . The centripetal force for an electron of mass m is

$$F = \frac{mv^2}{R} = evB$$

The energy of an electron in the dual beam tube is given by:

$$eU_A = \frac{1}{2}mv^2$$

By solving for v and replacing it in the equation the following emerges

$$\frac{e}{m} = \frac{2U_A}{B^2R^2}$$

The term e/m is the specific charge of an electron and has the constant value $(1.75888 \pm 0.0004) \times 10^{11}$ C/kg.

5.1.1 Determination of B

The Helmholtz coils have a diameter of 138 mm and give rise to a magnetic flux in Helmholtz configuration as given by

$$B = \mu_0 H = (4.17 \times 10^{-3}) I_H \text{ T/A}$$

- Connect up the tube as in Fig. 4.
- Dim the room lighting.
- Assure the correct positioning of the Helmholtz coils in Helmholtz configuration.
- Set the heater voltage U_F to 6.5 V and wait some minutes for the heater temperature to achieve thermal stability (see remarks in section 4.3).
- Set the anode voltage U_A to 90 V and wait until the anode current has stabilized (plate voltage $U_P = 0$ V).
- Set the current in the coils I_H so that the deviated beam passes through point A on the edge of the fluorescent screen of the tube. Simultaneously focus the beam using a plate voltage U_P of no more than 6 V.
- Increase U_A and set I_H so that the deflected beam always passes through A. Increase the anode voltage only to the extent that the anode current does not exceed 30 mA.
- Enter all the values into a table.

U_A in volts	I_H in amps
90	
100	
110	
120	

5.1.2 Determination of R

Referring to the diagram Fig. 1, the beam emerges from the electron gun at C travelling along the axis of the tube. The electron is then deflected in a circular path with the tube axis forming a tangent. The centre of this circle is at B and it lies in the plane of DCD' about 2 mm behind the plane of EE'.

$$AB^2 = BC^2 + AC^2 - 2BC \cdot DC$$

$$R = BC = AB = \frac{AC^2}{2DC} = \frac{x^2 + y^2}{2y}$$

$$R^2 = \left[\frac{x^2 + y^2}{2y} \right]^2$$

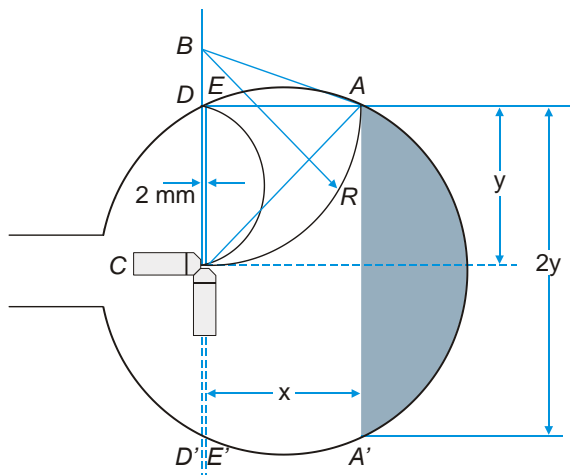

Fig. 1 Derivation of R

5.2 Deflection in a circular path and the determination of e/m

- Connect up the tube as in Fig. 5.
- Set the anode voltage U_A to 100 V and wait until the anode current has stabilized (plate voltage $U_P = 0$ V).
- Set the current in the coils I_H so that the deflected beam moves in a circular path with the plane AA' tangential to it.

It is practical in this instance to observe the beam from above, from where it appears as a straight line and can be focused using U_P to a maximum of 6 V.

Note: the axial non-linearity of the beam has the effect of pushing the beam out of the plane of the electron gun. In order to obtain more accurate results, the tube should be turned within the

brace that holds it so that the circular path is in the plane of the gun. I_H should also be modified so that plane AA' makes a good tangent with the path. A slight angle to the axis of the tube is tolerable. The beam travels in a slightly spiralling path instead of an accurate circle.

- Increase U_A and set I_H so that the plane AA' always forms a tangent to the deflected beam. Increase the anode voltage only to the extent that the anode current does not exceed 30 mA. Tabulate I_H against U_A and plot the graph.

- Evaluate $R = AE/2$ from experiment 5.1, $R^2 = AE^2/4$.

- Replace the values in the equation

$$\frac{e}{m} = \frac{U_A}{I_H^2 R^2} \cdot 1.15 \cdot 10^5$$

and calculate a mean value for e/m .

5.3 The effect of an axial magnetic field

- Place the tube in the stand at 90° to its normal alignment (refer to Fig. 2).
- Insert the coil in the slot of the tube holder so that the fluorescent screen is enclosed by a single Helmholtz coil.
- Connect up the tube as in Fig. 6.

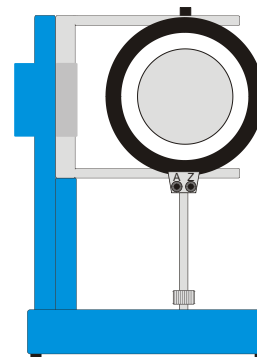

Fig. 2 Setting up the coil

- Set the anode voltage U_A to no more than 60 V and wait until the anode current has stabilized (plate voltage $U_P = 0$ V).
- Gradually increase the coil current I_H .

With only one axial velocity vector v_a the axial non-linearity of the beam is corrected and coincides with the true axis of the field.

- Mark the position of the beam with a felt-tip pen.
- Set I_H to 1.5 A and increase U_P gradually so that a second velocity vector v_p affects the beam.
- View the beam end-on through the coil.

The beam path turns into a helix. The beam no longer goes around the axis of the field but re-

turns to a different position along the axis after every loop.

- Reverse the polarity of the magnetic field B by reversing that of the Helmholtz coils and observe what happens to the beam.
- Change the anode voltage and observe its effect on the helical path of the beam. Then restore the voltage to 60 V. Increase the anode voltage only to the extent that the anode current does not exceed 30 mA.

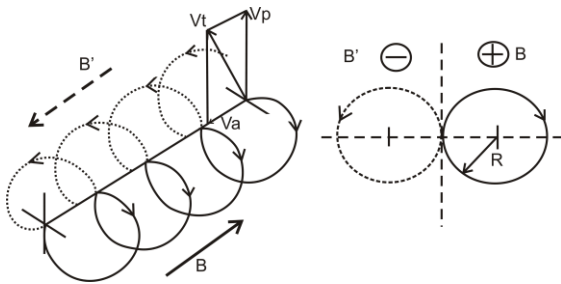

Fig. 3 Helical path of the deflected beam

6. Remarks

1. The circular beam path in experiment 5.2 is visible because of photo-emission. The energy involved in this process is lost and never replaced. This means that the beam actually tends to follow a spiral path instead of a circle. For a fixed radius R and a real circle U_A/H^2 would be larger than the values that we measure. For this reason the error in the value of e/m is always on the negative side. Nevertheless results can be achieved that are accurate to within 20%.

2. In experiments where the beams are deflected into semi-circular paths as in experiment 5.1 results are larger than the published value. Points A and E, through which the beam is deflected, lie outside the homogeneous region of the Helmholtz coils so that the magnetic flux is reduced at these points. For a fixed radius R and a truly homogeneous field U_A/H^2 would be smaller than the values we measure. For this reason the error in the value of e/m is always on the positive side. Nevertheless results can be achieved that are accurate to within 20%.

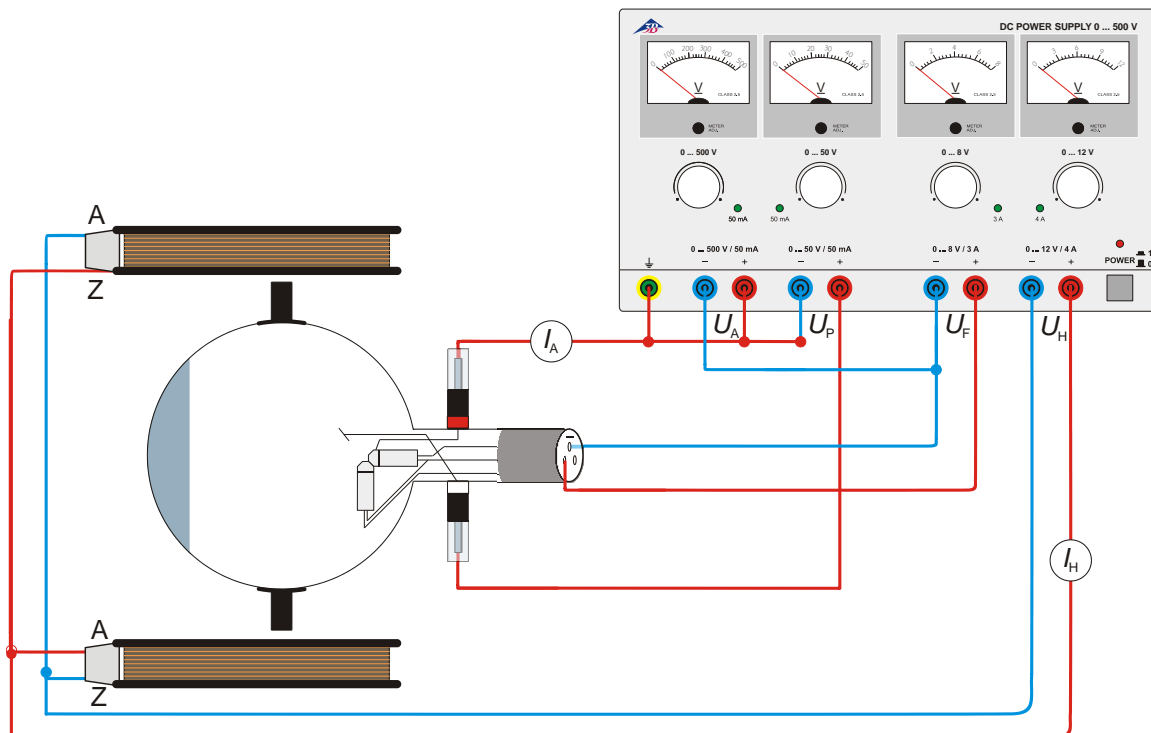

Fig. 4 Determining e/m using the axial electron gun

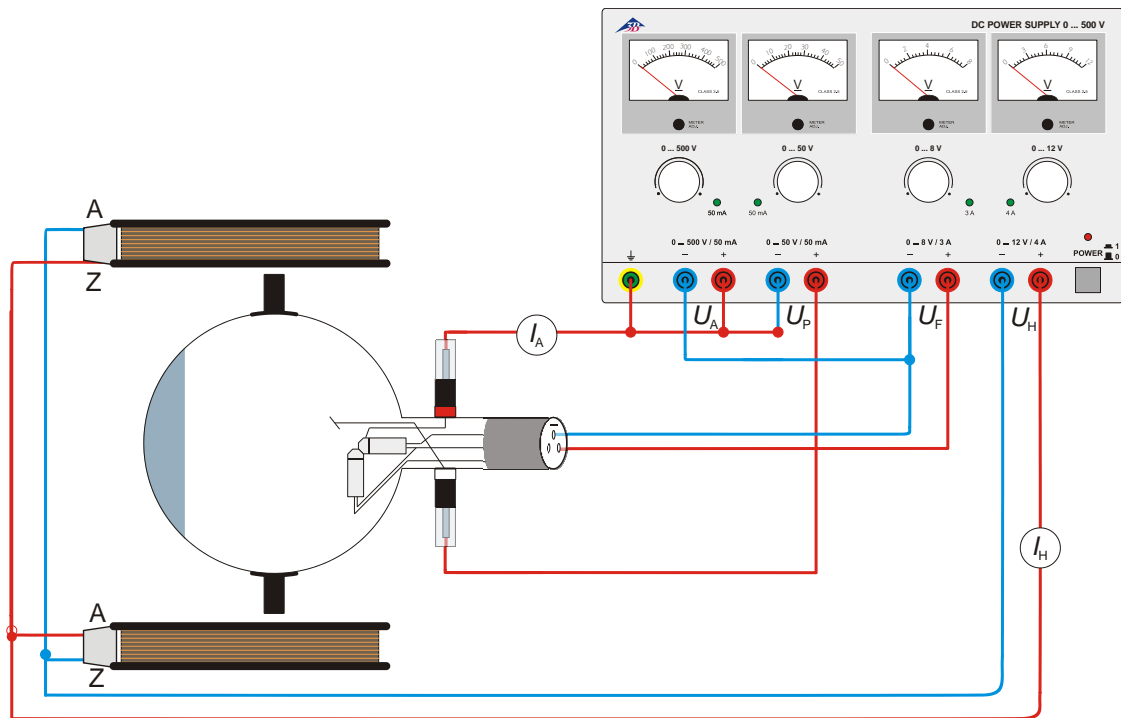

Fig. 5 Determining e/m using the perpendicular electron gun

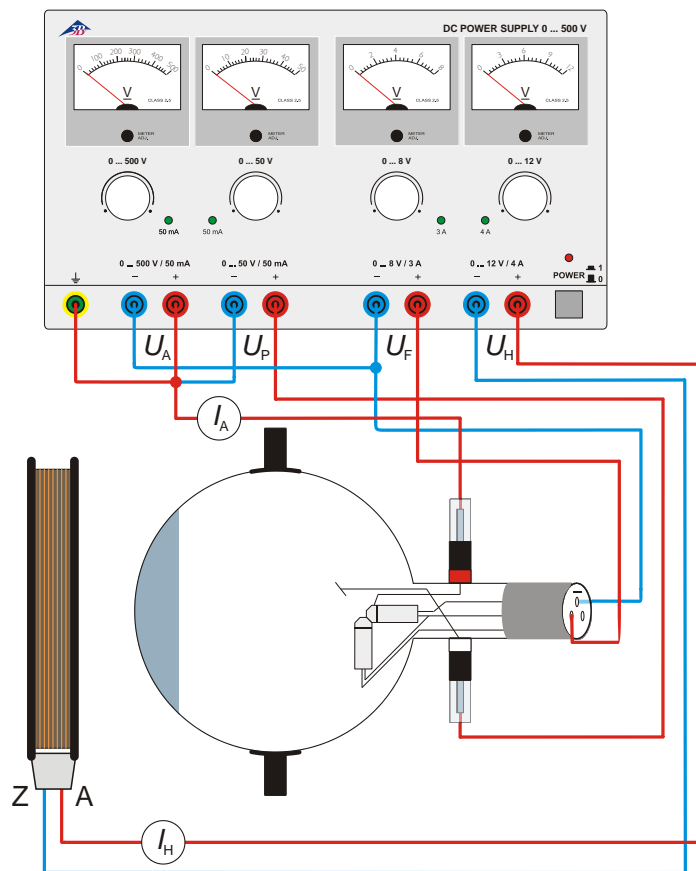

Fig. 6 The effect of an axial magnetic field

